

# DOUBLE TIER CHANDELIER

LF022

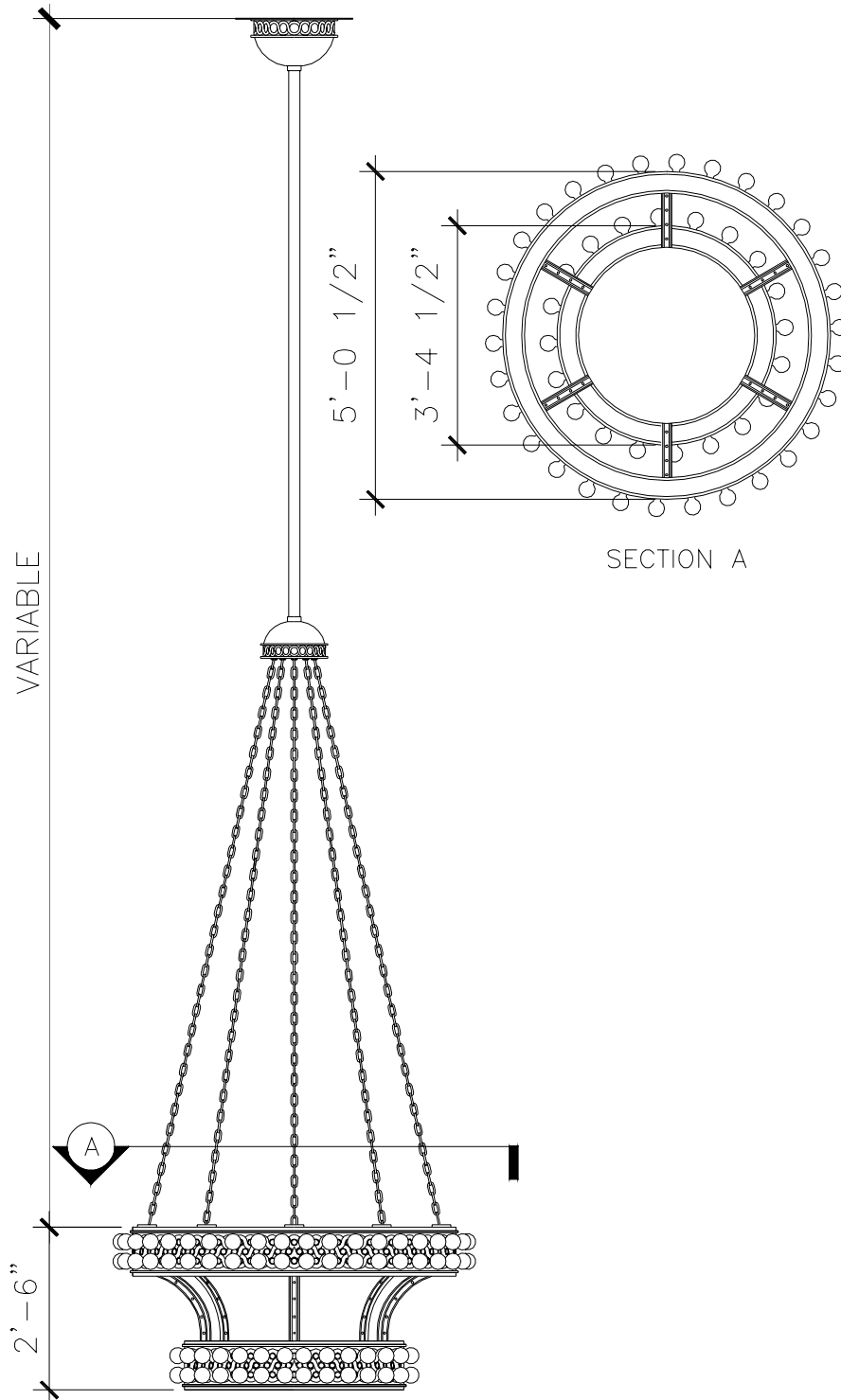

## RECOMMENDED MATERIALS

ALUMINUM  
BRONZE

## FINISHES

PAINTED, ANTIQUED  
PATINA, BRUSHED, HAND RUBBED

